

TIGUA

Aluminium alloy
EN 44300



LIGHTING

Palazzoli

Tailor-made lighting systems

TIGUA is the new lighting fixture specifically designed for floodlighting and pendant mounting applications.

The best light distribution is guaranteed for any condition, thanks to the multiple photometric solutions available.

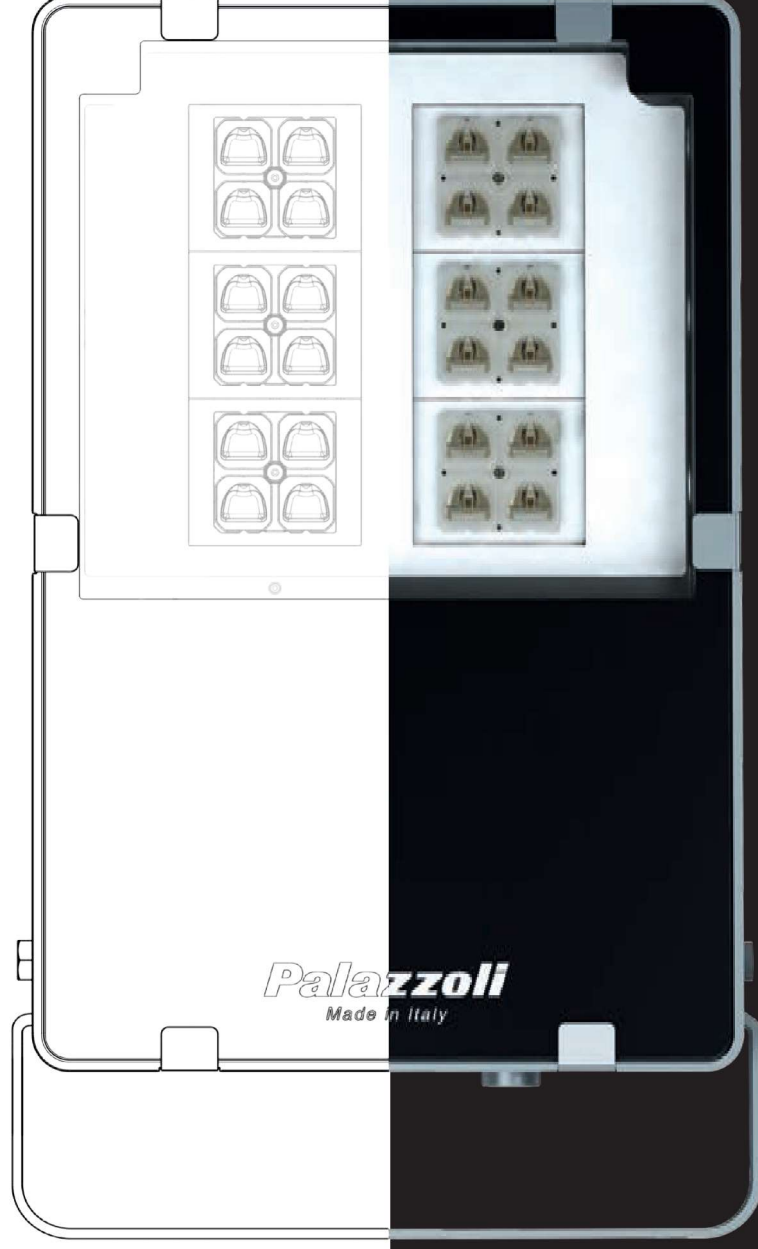

High performance

For any site lighting need, TIGUA is the best solution in terms of:

- technological performance
- energy saving
- ease of installation

Floodlights

Symmetrical
81° extra wide beam

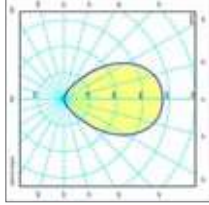

PAGE 8 Glass diffuser
PAGE 12 HT + 55°C
with glass diffuser

Symmetrical
36° narrow beam

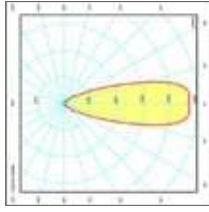

PAGE 8 Glass diffuser

Symmetrical
18° narrow beam

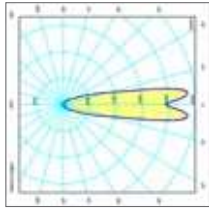

PAGE 9 Glass diffuser

Asymmetrical
23° extra wide beam

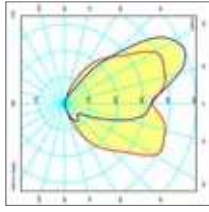

PAGE 10 Glass diffuser
PAGE 12 HT + 55°C
with glass diffuser

Asymmetrical
43° narrow beam

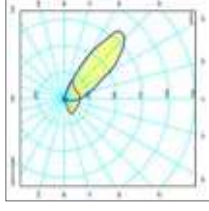

PAGE 10 Glass diffuser

Asymmetrical
55° narrow beam

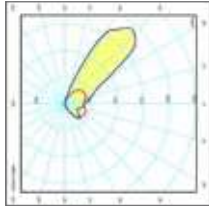

PAGE 11 Glass diffuser

Roadway
65° wide beam

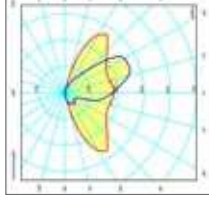

PAGE 14 Glass diffuser
PAGE 14 Glass diffuser
with pole-top bracket
PAGE 13 HT + 55°C with glass diffuser

Accessories

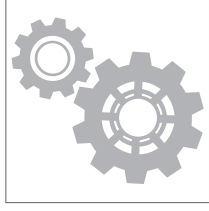

PAGE 15

Suspension

Symmetrical
81° extra wide beam

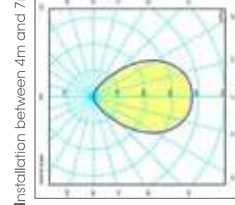

Installation: between 4m and 7m

PAGE 18 Glass diffuser
PAGE 20 Polycarbonate diffuser
PAGE 22 DALI with glass diffuser
PAGE 24 DALI with polycarbonate diffuser
PAGE 26 HT + 55°C with glass diffuser

Symmetrical
55° medium beam

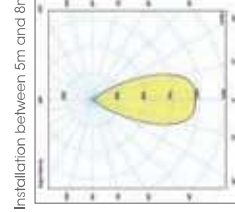

Installation: between 5m and 8m

PAGE 18 Glass diffuser
PAGE 20 Polycarbonate diffuser
PAGE 22 DALI with glass diffuser
PAGE 24 DALI with polycarbonate diffuser
PAGE 26 HT + 55°C with glass diffuser

Symmetrical
36° narrow beam

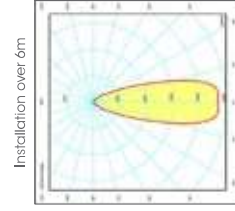

Installation: over 6m

PAGE 19 Glass diffuser
PAGE 21 Polycarbonate diffuser
PAGE 23 DALI with glass diffuser
PAGE 25 DALI with polycarbonate diffuser
PAGE 27 HT + 55°C with glass diffuser

Symmetrical
95°x41° elliptical beam

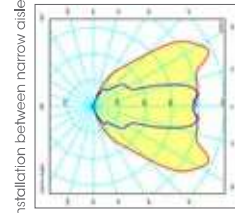

Installation: between narrow aisles

PAGE 19 Glass diffuser
PAGE 21 Polycarbonate diffuser
PAGE 23 DALI with glass diffuser
PAGE 25 DALI with polycarbonate diffuser
PAGE 27 HT + 55°C with glass diffuser

Accessories

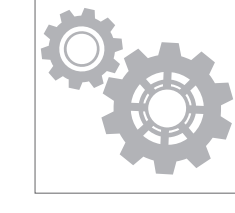

PAGE 28

Durable

The long life of TIGUA is guaranteed by various design and production features:

- high-quality electronic components
- exclusive thermal management system that keeps semiconductors unaltered over time
- X-ray testing of LED weld joints
- strict 100% testing with 24 hour burn-in cycles
- Gore-Tex® anti-condensation breathing valve.

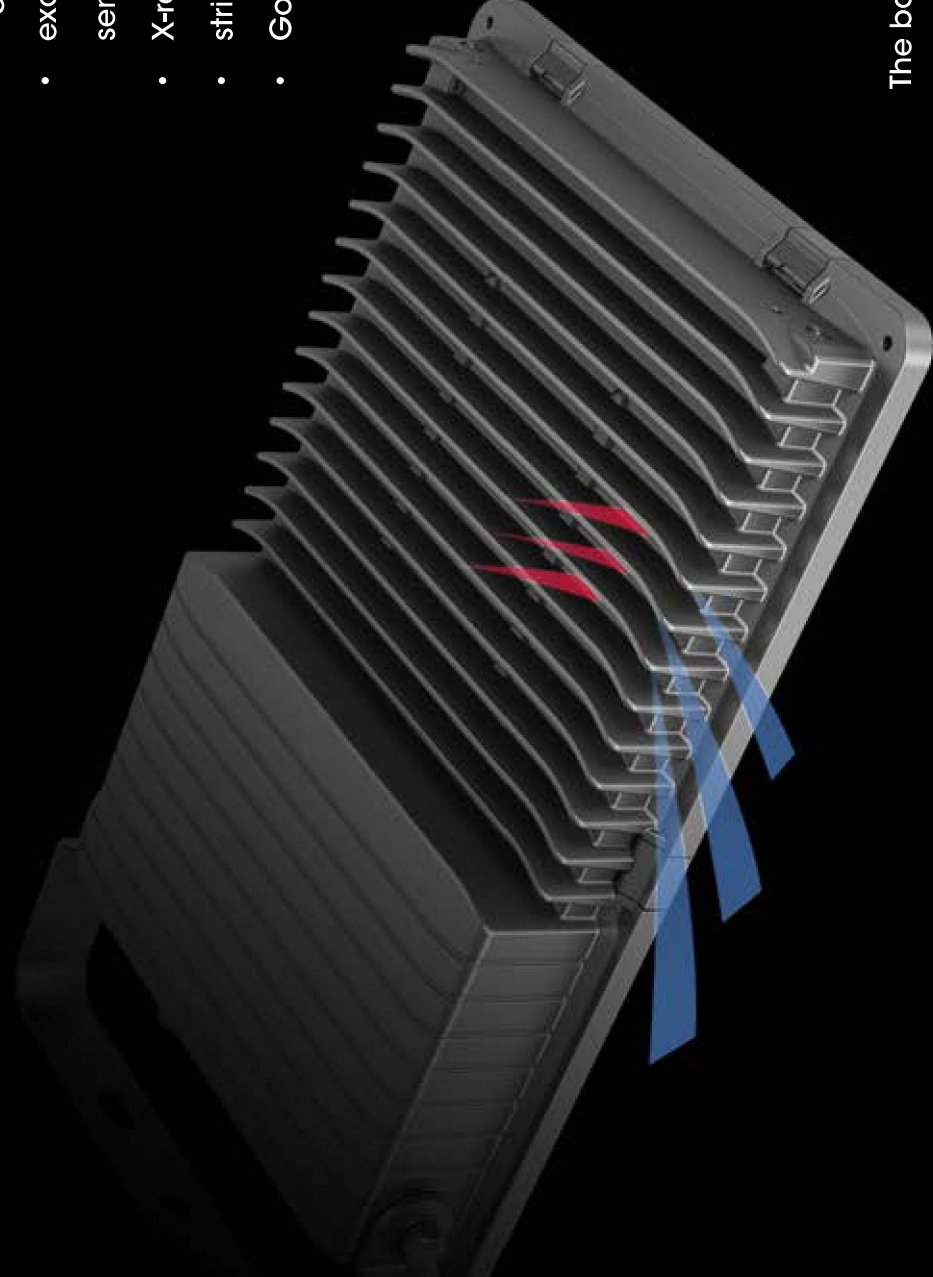

The body is made of EN 44300 aluminium alloy with low copper content (aeronautical grade alloy) suitable for harsh environments having a corrosion class C4.

Efficient and safe



FLICKER
FREE

The used LEDs allow TIGUA to achieve an output efficiency of up to 122 lumens/Watt. Colour rendering is ensured by the use of light sources with Colour Rendering Index (CRI) > 80.

TIGUA uses flicker-free power supplies and is free from photobiological risks.



RISK
GROUP
EXEMPT

The low glare index (UGR \leq 22) respects the eyesight of people in the working environment.

TIGUA is equipped with a connector that enables a quick connection to the power grid, with no need to open the light fixture. The IP66 protection rating therefore remains guaranteed.



ENERGY
SAVING

Great value and high ROI

TIGUA is a lighting system that pays for itself.

It reduces the cost of ownership of lighting while ensuring the highest quality.

The return on investment is guaranteed within three years and maintained, thanks to the long life of the devices (> 100,000 hours).



TIGUA floodlight



Datasheet



TIGUA, Palazzoli's new floodlight, represents the best solution for lighting industrial sites, facades, signs, commercial spaces, sport centres and green areas.

TIGUA consists of a die-cast aluminium body with very low copper content (aeronautical grade alloy), with anti-corrosion treatment, and a 4mm thick diffuser in extra-clear tempered glass, that ensure maximum resistance of the floodlight, even in harsh environments. The rear cooling fins and the electronic components used increase the service life of the unit.

The estimated life of the device is 100,000 hours. TIGUA is equipped with an adjustable painted galvanized steel bracket for on-site installation and adjustment.

The optical unit consists of LEDs with a colour temperature of 4000K and CRI ≥ 80 with a choice of optical solutions for symmetrical, asymmetrical and roadway light distribution. TIGUA benefits from a wide range of accessories that enable to easily install it in any environment: pole-top bracket, wall-mounted projecting bracket, U-plate. A front grille is also available to protect the entire unit.

TIGUA is the highest performing floodlight fixture on the market and the return on investment is guaranteed and maintained, thanks to the long life of the unit.

The photometric curves (LDT file) are available on www.palazzoli.com

Conformity to standards	Directive 2014/35/EU
	EN 60598-1
	EN 60598-2-1
	EN 60598-2-5
	EN 60598-2-22
	EN 62471
	EN 62493
	IEC/TR 62778
	Directive 2014/30/EU
	EN 55015
	EN 61547
	EN 61000-3-2
	EN 61000-3-3

EN 44300 die-cast aluminium
(aeronautical grade alloy)

Surface treatment Passivation with fluoro-zirconium treatment

Diffuser material Extra clear tempered glass

Protection rating
(IP as per IEC/EN 60529) **IP66**

Paint Hot-polymerized non-toxic polyester

Colour **RAL 7011**

Impact resistance
(IK rating as per IEC/EN 62262) **IK08**

Corrosion class
according to ISO 9223 **C4**

Weight **6.5 kg**

Device tilting angle **-135° - +135°**

LED device efficiency **up to 122 lm/W**

Colour temperature **4000K (other temperatures on request)**

CRI **≥ 80**

Insulation class **II**

Supply voltage **200-240 V 50-60 Hz**

Input surge protection
according to EN 61000-4-5 **8 kV common mode
6 kV differential mode**

Residual flicker **< 1%**

Photobiological risk **Exempt**

Power factor **≥ 0.95**

Max. conductor cross-section **1.5 mm²**

Entry cable diameter **7-13 mm**

Estimated device lifetime
**L80 B20 @ 100,000h Tq=-30 °C - +40 °C
Tq=-30 °C - +55 °C (HT version)**

Storage temperature **-40 °C - +70 °C**

Operating temperature **-30 °C - +40 °C**

-30 °C - +55 °C (HT version)

Floodlights



100000h



Professional LED floodlights
symmetrical 81°
extra wide beam optics
IP66

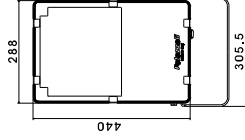
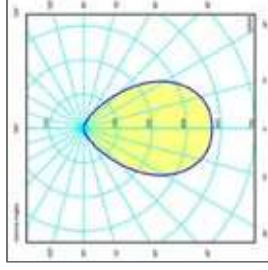

No. of LEDs	Device power (W)	Nominal flux (lm) Tj= 25 °C	Output flux (lm) Tq= 25 °C	Version	Palazzoli code	Pack Qty
8	67	9250	8064		817008	1
12	99	13875	11944		817012	1
16	132	18500	15926	on-off as standard	817016	1
20	153	23125	18032		817020	1
24	182	27750	22100		817024	1

Equipment included: wall-mounting bracket. Power supply with 2P quick connector.
 Notes: the stated values may be subject to a +/- 7% tolerance.

100000h



Professional LED floodlights
symmetrical 36°
narrow beam optics
IP66

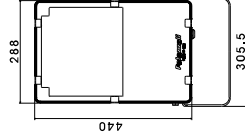
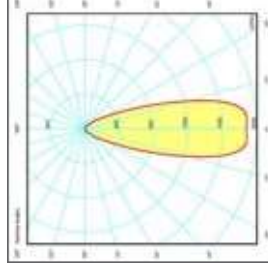

No. of LEDs	Device power (W)	Nominal flux (lm) Tj= 25 °C	Output flux (lm) Tq= 25 °C	Version	Palazzoli code	Pack Qty
8	67	9250	7515		817058	1
12	99	13875	11123		817062	1
16	132	18500	14831	on-off as standard	817066	1
20	145	23125	16924		817070	1
24	170	27750	20034		817074	1

Equipment included: wall-mounting bracket. Power supply with 2P quick connector.
 Notes: the stated values may be subject to a +/- 7% tolerance.

Floodlights



CORROSION
RESISTANT



FLICKER
FREE



2 YEARS WARRANTY
EXTENDABLE TO 5 YEARS



ENERGY SAVING UP
TO 60%

100.000h

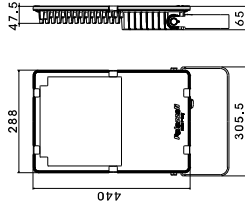
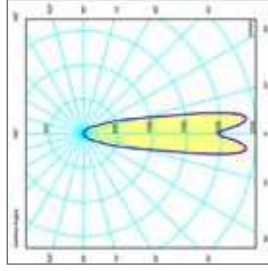

Professional LED floodlights
symmetrical 18°
narrow beam optics
IP66

No. of LEDs	Device power (W)	Nominal flux (lm) Tj= 25 °C	Output flux (lm) Tq= 25 °C	Version	Palazzoli code	Pack Qty
8	67	9250	7571		817758	1
12	99	13875	11187		817762	1
16	132	18500	14916	standard on-off	817766	1
20	145	23125	16385		817770	1
24	170	27750	19210		817774	1

Equipment included: wall-mounting bracket. Power supply with 2P quick connector.
Notes: the stated values may be subject to a +/- 7% tolerance.



Floodlights



CORROSION
RESISTANT



FLICKER
FREE



2 YEARS WARRANTY
EXTENDABLE TO 5 YEARS



ENERGY SAVING UP
TO 60%

100000h



Professional LED floodlights
asymmetrical 23°
extra wide beam optics
IP66

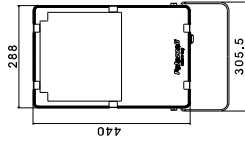
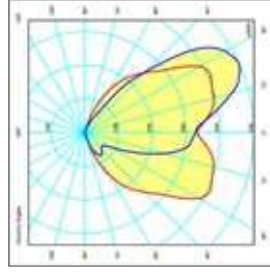

No. of LEDs	Device power (W)	Nominal flux (lm) Tj= 25 °C	Output flux (lm) Tq= 25 °C	Version	Palazzoli code	Pack Qty
8	67	9250	7966		817108	1
12	99	13875	11798		817112	1
16	132	18500	15731	on-off as standard	817116	1
20	145	23125	17631		817120	1
24	170	27750	21058		817124	1

Equipment included: wall-mounting bracket. Power supply with 2P quick connector.
Notes: the stated values may be subject to a +/- 7% tolerance.

100000h



Professional LED floodlights
asymmetrical 43°
narrow beam optics
IP66

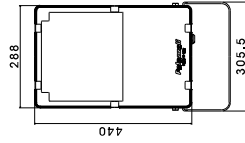
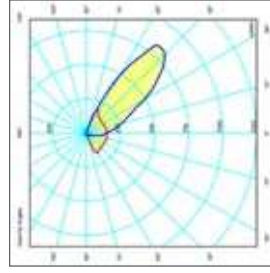

No. of LEDs	Device power (W)	Nominal flux (lm) Tj= 25 °C	Output flux (lm) Tq= 25 °C	Version	Palazzoli code	Pack Qty
8	67	9250	8051		817158	1
12	99	13875	11925		817162	1
16	132	18500	15900	on-off as standard	817166	1
20	145	23125	17823		817170	1
24	170	27750	20899		817174	1

Equipment included: wall-mounting bracket. Power supply with 2P quick connector.
Notes: the stated values may be subject to a +/- 7% tolerance.

Floodlights



CORROSION
RESISTANT



FLICKER
FREE



2 YEARS WARRANTY
EXTENDABLE TO 5 YEARS



ENERGY SAVING UP
TO 60%

100.000h



Professional LED floodlights
asymmetrical 55°
narrow beam optics
IP66

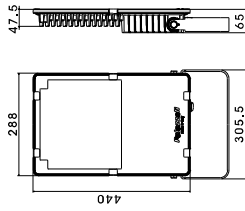
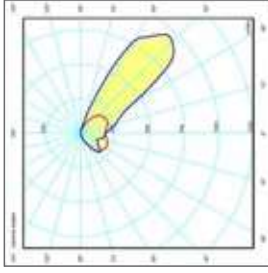

No. of LEDs	Device power (W)	Nominal flux (lm) Tj= 25 °C	Output flux (lm) Tq= 25 °C	Version	Palazzoli code	Pack Qty
8	67	9250	7966		817708	1
12	99	13875	11798		817712	1
16	132	18500	15731	standard on-off	817716	1
20	145	23125	17631		817720	1
24	170	27750	21058		817724	1

Equipment included: wall-mounting bracket. Power supply with 2P quick connector.
Notes: the stated values may be subject to a +/- 7% tolerance.



HT +55 °C Floodlights



CORROSION
RESISTANT



FLICKER
FREE



2 YEARS WARRANTY
EXTENDABLE TO 5 YEARS



ENERGY SAVING UP
TO 60%

100000h



Professional LED floodlights
HT +55 °C
symmetrical 81°
extra wide beam optics
IP66

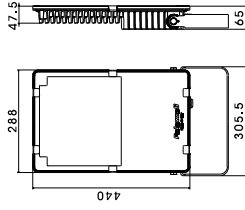
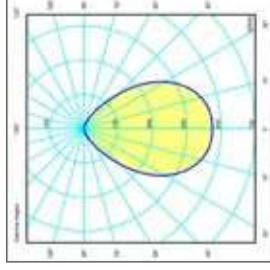

No. of LEDs	Device power (W)	Nominal flux (lm) Tj= 25 °C	Output flux (lm) Tq= 25 °C	Version	Palazzoli code	Pack Qty
8	67	9250	6954		817008HT	1
12	74	11575	8593		817012HT	1
16	94	15434	10990	on-off as standard	817016HT	1
20	112	18135	13292		817020HT	1
24	133	21761	15746		817024HT	1

Equipment included: wall-mounting bracket. Power supply with 2P quick connector.
Notes: the stated values may be subject to a +/- 7% tolerance.

100000h



Professional LED floodlights
HT +55 °C
asymmetrical 23°
extra wide beam optics
IP66

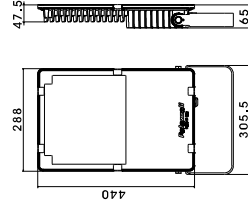
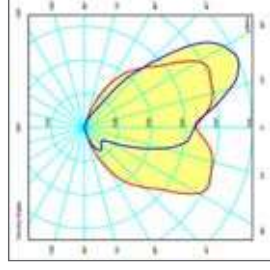

No. of LEDs	Device power (W)	Nominal flux (lm) Tj= 25 °C	Output flux (lm) Tq= 25 °C	Version	Palazzoli code	Pack Qty
8	67	9250	6870		817108HT	1
12	74	11575	8488		817112HT	1
16	94	15434	10865	on-off as standard	817116HT	1
20	112	18135	13128		817120HT	1
24	133	21761	15549		817124HT	1

Equipment included: wall-mounting bracket. Power supply with 2P quick connector.
Notes: the stated values may be subject to a +/- 7% tolerance.

HT +55 °C Floodlights



CORROSION
RESISTANT



FLICKER
FREE



2 YEARS WARRANTY
EXTENDABLE TO 5 YEARS



ENERGY SAVING UP
TO 60%

100000h

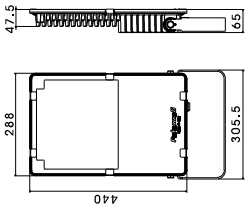
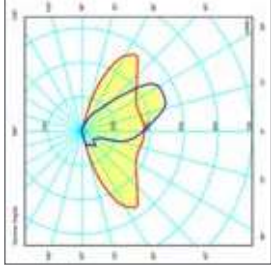

Professional LED floodlights
HT +55 °C
roadway 65° wide beam optics
IP66

No. of LEDs	Device power (W)	Nominal flux (lm) Tj= 25 °C	Output flux (lm) Tq= 25 °C	Version	Palazzoli code	Pack Qty
8	67	9250	6662		817208HT	1
12	74	11575	8228		817212HT	1
16	94	15434	10532	on-off as standard	817216HT	1
20	112	18135	12721		817220HT	1
24	133	21761	15060		817224HT	1

Equipment included: wall-mounting bracket. Power supply with 2P quick connector.
Notes: the stated values may be subject to a +/- 7% tolerance.



Roadway Floodlights



CORROSION
RESISTANT



FLICKER
FREE



2 YEARS WARRANTY
EXTENDABLE TO 5 YEARS



ENERGY SAVING UP
TO 60%

100000h



Professional LED floodlights
**roadway 65° wide beam optics
IP66**

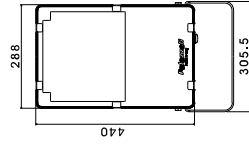
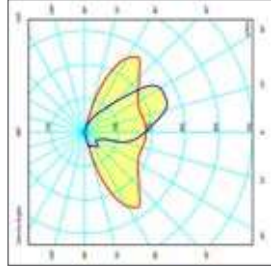

No. of LEDs	Device power (W)	Nominal flux (lm) Tj= 25 °C	Output flux (lm) Tq= 25 °C	Version	Palazzoli code	Pack Qty
8	67	9250	7584		817208	1
12	99	13875	11227		817212	1
16	132	18500	14970	on-off as standard	817216	1
20	145	23125	17084		817220	1
24	170	27750	20226		817224	1

Equipment included: wall-mounting bracket. Power supply with quick connector.
Notes: the stated values may be subject to a +/- 7% tolerance.

100000h



Professional LED floodlights
**roadway 65° wide beam optics
with pole-top mounting
IP66**

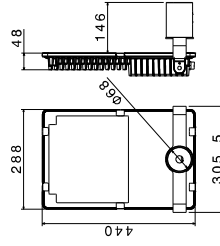
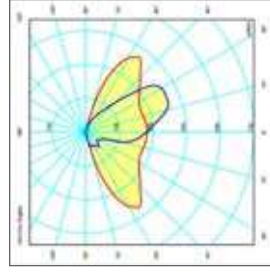

No. of LEDs	Device power (W)	Nominal flux (lm) Tj= 25 °C	Output flux (lm) Tq= 25 °C	Version	Palazzoli code	Pack Qty
8	67	9250	7584		817258	1
12	99	13875	11227		817262	1
16	132	18500	14970	on-off as standard	817266	1
20	145	23125	17084		817270	1
24	170	27750	20226		817274	1

Equipment included: 42-60 mm pole mounting bracket. Power supply with 2P quick connector.
Features: adjustment for pole-top application from 0° to +15°.
Adjustment for wall mounting with projecting arm from 0° to -20°.
Notes: the stated values may be subject to a +/- 7% tolerance.

Accessories



Universal mount for pole-top installation
and projecting arm bracket for poles
Ø 60 mm and Ø 76 mm

Manufacturing material	Palazzoli code	Pack Qty
painting galvanized steel	811908	1

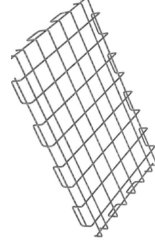

Protection grid
for TIGUA floodlights

Manufacturing material	Palazzoli code	Pack Qty
galvanized steel	811911	1



Projecting arm mounting bracket,
750 mm projection

Manufacturing material	Palazzoli code	Pack Qty
painting galvanized steel	811914	1



Kit consisting of collar and plate
for Ø 60 mm to Ø 80 mm pole mounting

Manufacturing material	Palazzoli code	Pack Qty
painting galvanized steel	811912	1

TIGUA Low Bay



Datasheet



TIGUA, Palazzoli's new low bay light fixture, is the best solution for lighting commercial and industrial areas, and was designed to last as long as the building it illuminates. TIGUA consists of a die-cast aluminium body with very low copper content (aeronautical grade alloy), anti-corrosion treatment, and a 4mm thick diffuser in extra-clear tempered glass, that ensure maximum resistance of the device, even in harsh environments.

The rear cooling fins and the electronic components used increase the service life of the unit. The estimated life of the device is over 120,000 hours (over 30 years).

If used in the food industry, the entire range can be fitted with a polycarbonate diffuser, in compliance with HACCP regulations. All the TIGUA low bay versions can be equipped with 1 hour or 3 hour emergency module.

The optical unit consists of LEDs with a colour temperature of 4000K and CRI ≥ 80 , a choice of optical solutions for wide beam, medium beam, narrow beam and elliptical beam, and a very low glare index (UGR ≤ 22).

TIGUA is available with accessories that allow pendant, adjustable pendant, ceiling or horizontal pole mounting, so that the light fixture can easily fit in various environments.

TIGUA is the highest performing floodlight fixture on the market and the return on investment is guaranteed and maintained, thanks to the long life of the unit.

The photometric curves (LDT file) are available on www.palazzoli.com

Conformity to standards	Directive 2014/35/EU EN 60598-1 EN 60598-2-1 EN 60598-2-5 EN 60598-2-22 EN 62471 EN 62493 IEC/TR 62778 Directive 2014/30/EU EN 55015 EN 61547 EN 61000-3-2 EN 61000-3-3 Directive 2011/65/EU EN 50581 DIN 18032-3 EN 13964 Annex D EN 60598-2-24 EN 44300 die-cast aluminium (aeronautical grade alloy)
-------------------------	--

Body material	EN 44300 die-cast aluminium (aeronautical grade alloy)
Surface treatment	Passivation with fluoro-zirconium treatment
Diffuser material	Extra clear tempered glass or polycarbonate
Protection rating (IP as per IEC/EN 60529)	IP66
Paint	Hot-galvanized non-toxic polyester
Colour	RAL 7011
Impact resistance (IK rating as per IEC/EN 62262)	IK08
Corrosion class	C4 according to ISO 9223
Weight	6.5 kg
LED device efficiency	up to 122 lm/W
Colour temperature	4000K (other temperatures on request)
CRI	≥ 80
Insulation class	I
Supply voltage	200-240 V 50-60 Hz
Input surge protection according to EN 61000-4-5	8 kV common mode 6 kV differential mode
Residual flicker	$< 1\%$
Photobiological risk	Exempt
Glare index	UGR ≤ 22 ; UGR < 25
Power factor	≥ 0.95
Max. conductor cross-section	1.5 mm ²
Entry cable diameter	7-13 mm
Emergency battery lifetime	1-3 h
Emergency battery charging time	24 h
Estimated device lifetime	L80 B20 @ 120,000h Tq=-30 °C - +40 °C Tq=-30 °C - +55 °C (HT version)
Storage temperature	-40 °C - +70 °C
Operating temperature	-30 °C - +40 °C -30 °C - +55 °C (HT version)

120000h | UGR<25



Suspension LED light fixtures
glass diffuser
81° extra wide beam optics
IP66

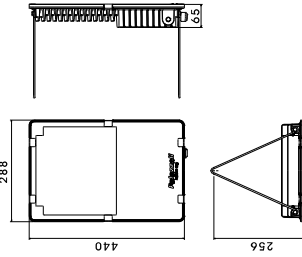
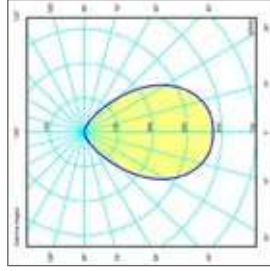

No. of LEDs	Device power (W)	Nominal flux (lm) Tj= 25 °C	Output flux (lm) Tq= 25 °C	Version	Palazzoli code	Pack Qty
4	33	4625	3958	standard dimmable 1-10V	817304	1
8	67	9250	8064		817308	1
12	99	13875	11944		817312	1
16	132	18500	15926		817316	1
20	153	23125	18032		817320	1
24	182	27750	22100		817324	1
4	33	4625	3958	emergency*	817305	1
8	67	9250	8064		817309	1
12	99	13875	11944		817313	1
16	132	18500	15926		817317	1
20	153	23125	18032		817321	1
24	182	27750	22100		817325	1

Equipment included: double chain bracket and busbar. Power supply with 5P quick connector. (2 connectors for the versions in emergency).

Features: typical installation height between 4 and 7 m.

*The emergency version is to be completed with the kit on page 28.

Notes: the stated values may be subject to a +/- 7% tolerance.

Wireless control systems available on request.

120000h | UGR<22



Suspension LED light fixtures
glass diffuser
55° medium beam optics
IP66

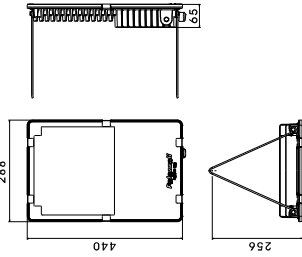
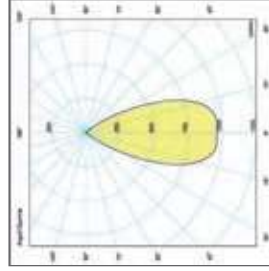

No. of LEDs	Device power (W)	Nominal flux (lm) Tj= 25 °C	Output flux (lm) Tq= 25 °C	Version	Palazzoli code	Pack Qty
4	33	4625	3789	1-10V dimmable as standard	817354	1
8	67	9250	7577		817358	1
12	99	13875	11218		817362	1
16	132	18500	14957		817366	1
20	145	23125	17069		817370	1
24	170	27750	20208		817374	1
4	33	4625	3789	emergency*	817355	1
8	67	9250	7577		817359	1
12	99	13875	11218		817363	1
16	132	18500	14957		817367	1
20	145	23125	17069		817371	1
24	170	27750	20208		817375	1

Equipment included: double chain bracket and busbar. Power supply with 5P quick connector. (2 connectors for the versions in emergency).

Features: typical installation height between 5 and 8 m.

*The emergency version is to be completed with the kit on page 28.

Notes: the stated values may be subject to a +/- 7% tolerance.

Wireless control systems available on request.

120000h | UGR≤22



Low bay LED light fixtures
glass diffuser
36° narrow beam optics
IP66

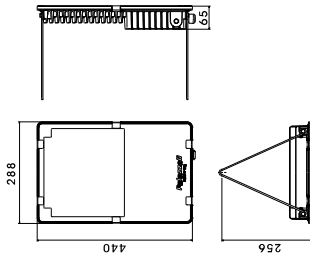
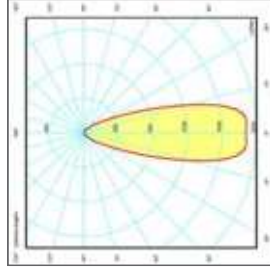

Equipment included: double chain bracket and busbar. Power supply with 5P quick connector.
 (2 connectors for the versions in emergency).

Features: typical installation height over 6 m.

*The emergency version is to be completed with the kit on page 28.

Notes: the stated values may be subject to a +/- 7% tolerance.

Wireless control systems available on request.

No. of LEDs	Device power (W)	Nominal flux (lm) Tj= 25 °C	Output flux (lm) Tq= 25 °C	Version	Palazzoli code	Pack Qty
4	33	4625	3757	1-10 V dimmable as standard	817404	1
8	67	9250	7515		817408	1
12	99	13875	11123		817412	1
16	132	18500	14831		817416	1
20	145	23125	16924		817420	1
24	170	27750	20034		817424	1
4	33	4625	3757	emergency*	817405	1
8	67	9250	7515		817409	1
12	99	13875	11123		817413	1
16	132	18500	14831		817417	1
20	145	23125	16924		817421	1
24	170	27750	20034		817425	1

120000h | UGR≤22



Suspension LED light fixtures
glass diffuser
95°x41° elliptical beam optics
IP66

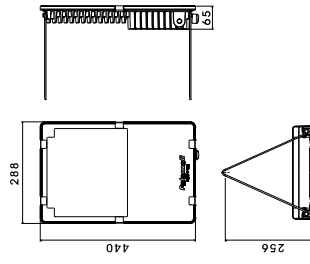
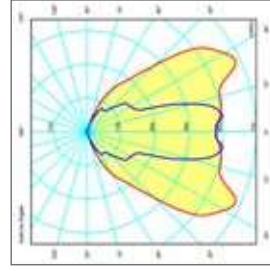

Equipment included: double chain bracket and busbar. Power supply with 5P quick connector.
 (2 connectors for the versions in emergency).

Features: suitable for installation between the aisles of industrial warehouses.

* The emergency version is to be completed with the kit on page 28.

Notes: the stated values may be subject to a +/- 7% tolerance.

Wireless control systems available on request.

No. of LEDs	Device power (W)	Nominal flux (lm) Tj= 25 °C	Output flux (lm) Tq= 25 °C	Version	Palazzoli code	Pack Qty
4	33	4625	3864	1-10 V dimmable as standard	817454	1
8	67	9250	7728		817458	1
12	99	13875	11444		817462	1
16	132	18500	15258		817466	1
20	153	23125	17418		817470	1
24	182	27750	20627		817474	1
4	33	4625	3864	emergency*	817455	1
8	67	9250	7728		817459	1
12	99	13875	11444		817463	1
16	132	18500	15258		817467	1
20	153	23125	17418		817471	1
24	182	27750	20627		817475	1

Food industry



1-10V DIMMABLE



CORROSION RESISTANT



FLICKER FREE



2 YEARS WARRANTY EXTENDABLE TO 5 YEARS



ENERGY SAVING UP TO 60%

120000h | UGR<25



Suspension LED light fixtures
HACCP-compliant
for food industry
polycarbonate diffuser
81° extra wide beam optics
IP66

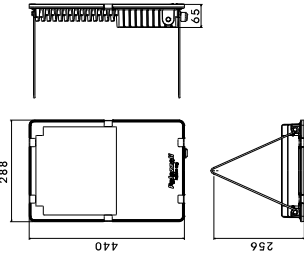
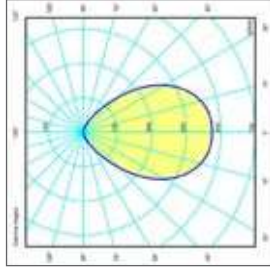

No. of LEDs	Device power (W)	Nominal flux (lm) Tj= 25 °C	Output flux (lm) Tq= 25 °C	Version	Palazzoli code	Pack Qty
4	33	4625	3958	1-10 V dimmable as standard	817504	1
8	67	9250	8064		817508	1
12	99	13875	11944		817512	1
16	132	18500	15926		817516	1
20	153	23125	18032		817520	1
24	182	27750	22100		817524	1
4	33	4625	3958	emergency*	817505	1
8	67	9250	8064		817509	1
12	99	13875	11944		817513	1
16	132	18500	15926		817517	1
20	153	23125	18032		817521	1
24	182	27750	22100		817525	1

Equipment included: double chain bracket and busbar. Power supply with 5P quick connector. (2 connectors for the versions in emergency).

Features: typical installation height between 4 and 7 m.

*The emergency version is to be completed with the kit on page 28.

Notes: the stated values may be subject to a +/- 7% tolerance.

Wireless control systems available on request.

120000h | UGR<25



Suspension LED light fixtures
HACCP-compliant
for food industry
polycarbonate diffuser
55° medium beam optics
IP66

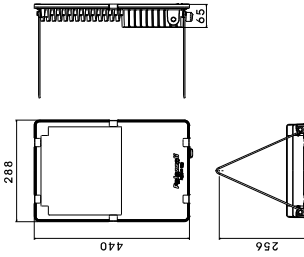
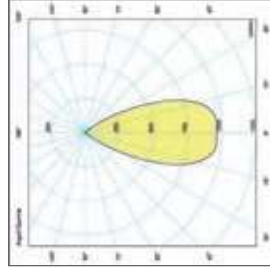

No. of LEDs	Device power (W)	Nominal flux (lm) Tj= 25 °C	Output flux (lm) Tq= 25 °C	Version	Palazzoli code	Pack Qty
4	33	4625	3789	1-10 V dimmable as standard	817554	1
8	67	9250	7577		817558	1
12	99	13875	11218		817562	1
16	132	18500	14957		817566	1
20	145	23125	17069		817570	1
24	170	27750	20208		817574	1
4	33	4625	3789	emergency*	817555	1
8	67	9250	7577		817559	1
12	99	13875	11218		817563	1
16	132	18500	14957		817567	1
20	145	23125	17069		817571	1
24	170	27750	20208		817575	1

Equipment included: double chain bracket and busbar. Power supply with 5P quick connector. (2 connectors for the versions in emergency).

Features: typical installation height between 5 and 8 m.

*The emergency version is to be completed with the kit on page 28.

Notes: the stated values may be subject to a +/- 7% tolerance.

Wireless control systems available on request.

Food industry

-30°C
+40°C

1-10V
DIMMIABLE



CORROSION
RESISTANT



FLICKER
FREE



2 YEARS WARRANTY
EXTENDABLE TO 5 YEARS



ENERGY SAVING UP
TO 60%

120000h | UGR≤22



Suspension LED light fixtures
HACCP-compliant
for food industry
polycarbonate diffuser
36° narrow beam optics
IP66

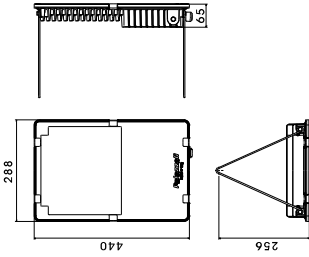
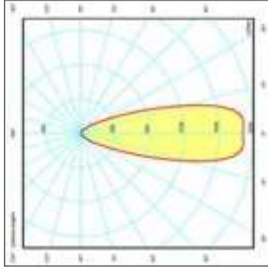

No. of LEDs	Device power (W)	Nominal flux (lm) Tj= 25 °C	Output flux (lm) Tq= 25 °C	Version	Palazzoli code	Pack Qty
4	33	4625	3757	1-10 V dimmable as standard	817604	1
8	67	9250	7515		817608	1
12	99	13875	11123		817612	1
16	132	18500	14831		817616	1
20	145	23125	16924		817620	1
24	170	27750	20034		817624	1
4	33	4625	3757	emergency*	817605	1
8	67	9250	7515		817609	1
12	99	13875	11123		817613	1
16	132	18500	14831		817617	1
20	145	23125	16924		817621	1
24	170	27750	20034		817625	1

Equipment included: double chain bracket and busbar. Power supply with 5P quick connector. (2 connectors for the versions in emergency).

Features: typical installation height over 6 m.

*The emergency version is to be completed with the kit on page 28.

Notes: the stated values may be subject to a +/- 7% tolerance.

Wireless control systems available on request.

120000h | UGR≤22



Suspension LED light fixtures
HACCP-compliant
for food industry
polycarbonate diffuser
95°x41° elliptical beam optics
IP66

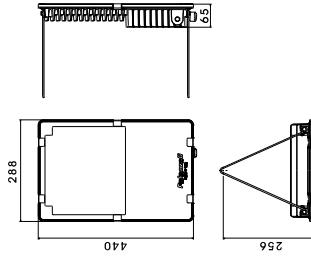
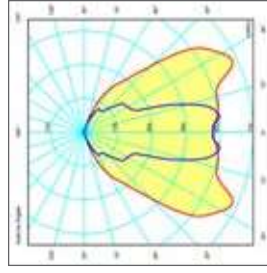

No. of LEDs	Device power (W)	Nominal flux (lm) Tj= 25 °C	Output flux (lm) Tq= 25 °C	Version	Palazzoli code	Pack Qty
4	33	4625	3864	1-10 V dimmable as standard	817654	1
8	67	9250	7728		817658	1
12	99	13875	11444		817662	1
16	132	18500	15258		817666	1
20	153	23125	17418		817670	1
24	182	27750	20627		817674	1
4	33	4625	3864	emergency*	817655	1
8	67	9250	7728		817659	1
12	99	13875	11444		817663	1
16	132	18500	15258		817667	1
20	153	23125	17418		817671	1
24	182	27750	20627		817675	1

Equipment included: double chain bracket and busbar. Power supply with 5P quick connector. (2 connectors for the versions in emergency).

Features: suitable for installation between the aisles of food warehouses.

*The emergency version is to be completed with the kit on page 28.

Notes: the stated values may be subject to a +/- 7% tolerance.

Wireless control systems available on request.

DALI industrial



CORROSION
RESISTANT



FLICKER
FREE



2 YEARS WARRANTY
EXTENDABLE TO 5 YEARS



ENERGY SAVING UP
TO 60%

120000h | UGR<25



DALI pendant LED light fixtures
glass diffuser
81° extra wide beam optics
IP66

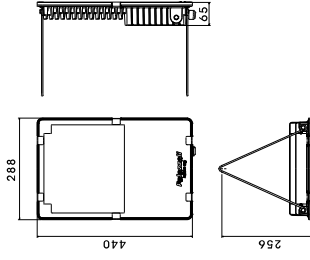
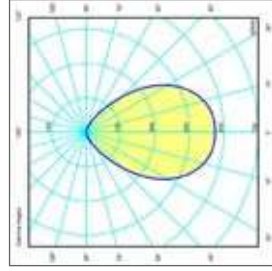

Equipment included: double chain bracket and busbar. Power supply with 5P quick connector.

Features: typical installation height between 4 and 7 m.

Notes: the stated values may be subject to a +/- 7% tolerance.

Wireless control systems available on request.

No. of LEDs	Device power (W)	Nominal flux (lm) Tj= 25 °C	Output flux (lm) Ta= 25 °C	Version	Palazzoli code	Pack Qty
4	33	4625	3958		817304DA	1
8	67	9250	8064		817308DA	1
12	99	13875	11944	dimmmable	817312DA	1
16	132	18500	15926	DALI	817316DA	1
20	153	23125	18032		817320DA	1
24	182	27750	22100		817324DA	1

120000h | UGR≤22



DALI low bay LED light fixtures
glass diffuser
55° medium beam optics
IP66

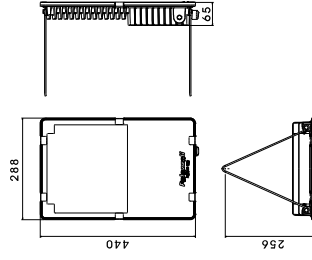
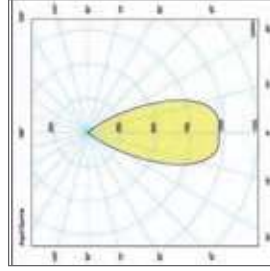

Equipment included: double chain bracket and busbar. Power supply with 5P quick connector.

Features: typical installation height between 5 and 8 m.

Notes: the stated values may be subject to a +/- 7% tolerance.

Wireless control systems available on request.

No. of LEDs	Device power (W)	Nominal flux (lm) Tj= 25 °C	Output flux (lm) Ta= 25 °C	Version	Palazzoli code	Pack Qty
4	33	4625	3789		817354DA	1
8	67	9250	7577		817358DA	1
12	99	13875	11218	dimmmable	817362DA	1
16	132	18500	14957	DALI	817366DA	1
20	145	23125	17069		817370DA	1
24	170	27750	20208		817374DA	1

DALI industrial



CORROSION RESISTANT



FLICKER FREE



2 YEARS WARRANTY EXTENDABLE TO 5 YEARS



ENERGY SAVING UP TO 60%

120000h | UGR≤22



DALI low bay LED light fixtures
glass diffuser
36° narrow beam optics
IP66

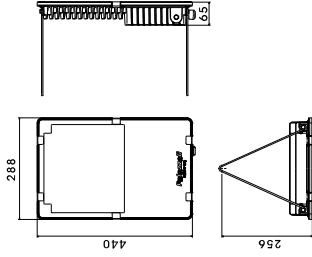
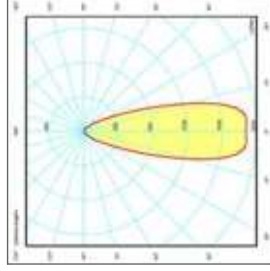

No. of LEDs	Device power (W)	Nominal flux (lm) Tj= 25 °C	Output flux (lm) Ta= 25 °C	Version	Palazzoli code	Pack Qty
4	33	4625	3757		817404DA	1
8	67	9250	7515		817408DA	1
12	99	13875	11123	dimmmable	817412DA	1
16	132	18500	14831	DALI	817416DA	1
20	145	23125	16924		817420DA	1
24	170	27750	20034		817424DA	1

Equipment included: double chain bracket and busbar. Power supply with 5P quick connector.

Features: typical installation height over 6 m.

Notes: the stated values may be subject to a +/- 7% tolerance.

Wireless control systems available on request.

120000h | UGR≤22



DALI low bay LED light fixtures
glass diffuser
95°x41° elliptical beam optics
IP66

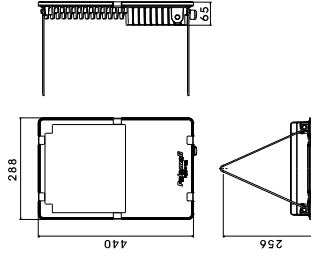
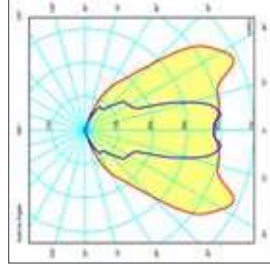

No. of LEDs	Device power (W)	Nominal flux (lm) Tj= 25 °C	Output flux (lm) Ta= 25 °C	Version	Palazzoli code	Pack Qty
4	33	4625	3864		817454DA	1
8	67	9250	7728		817458DA	1
12	99	13875	11444	dimmmable	817462DA	1
16	132	18500	15258	DALI	817466DA	1
20	153	23125	17418		817470DA	1
24	182	27750	20627		817474DA	1

Equipment included: double chain bracket and busbar. Power supply with 5P quick connector.

Features: suitable for installation between the aisles of industrial warehouses.

Notes: the stated values may be subject to a +/- 7% tolerance.

Wireless control systems available on request.

DALI food industry



CORROSION
RESISTANT



FLICKER
FREE



2 YEARS WARRANTY
EXTENDABLE TO 5 YEARS



ENERGY SAVING UP
TO 60%

120000h | UGR<25



**DALI pendant LED light fixtures
HACCP-compliant
for food industry
polycarbonate diffuser
81° extra wide beam optics
IP66**

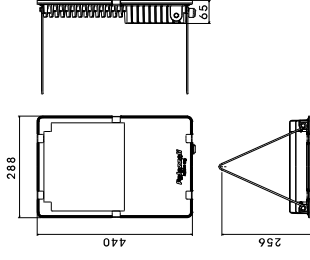
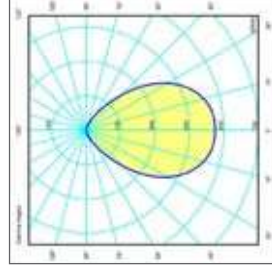

No. of LEDs	Device power (W)	Nominal flux (lm) Tj= 25 °C	Output flux (lm) Tq= 25 °C	Version	Palazzoli code	Pack Qty
4	33	4625	3958		817504DA	1
8	67	9250	8064		817508DA	1
12	99	13875	11944	dimmmable	817512DA	1
16	132	18500	15926	DALI	817516DA	1
20	153	23125	18032		817520DA	1
24	182	27750	22100		817524DA	1

Equipment included: double chain bracket and busbar. Power supply with 5P quick connector.

Features: typical installation height between 4 and 7 m.

Notes: the stated values may be subject to a +/- 7% tolerance.

Wireless control systems available on request.

120000h | UGR≤22



**DALI pendant LED light fixtures
HACCP-compliant
for food industry
polycarbonate diffuser
55° medium beam optics
IP66**

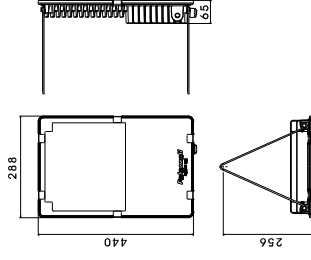
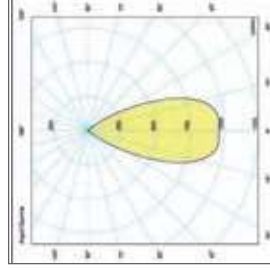

No. of LEDs	Device power (W)	Nominal flux (lm) Tj= 25 °C	Output flux (lm) Tq= 25 °C	Version	Palazzoli code	Pack Qty
4	33	4625	3789		817554DA	1
8	67	9250	7577		817558DA	1
12	99	13875	11218	dimmmable	817562DA	1
16	132	18500	14957	DALI	817566DA	1
20	145	23125	17069		817570DA	1
24	170	27750	20208		817574DA	1

Equipment included: double chain bracket and busbar. Power supply with 5P quick connector.

Features: typical installation height between 5 and 8 m.

Notes: the stated values may be subject to a +/- 7% tolerance.

Wireless control systems available on request.

DALI food industry



CORROSION
RESISTANT



FLICKER
FREE



2 YEARS WARRANTY
EXTENDABLE TO 5 YEARS



ENERGY SAVING UP
TO 60%

120000h | UGR≤22



**DALI pendant LED light fixtures
HACCP-compliant
for food industry
polycarbonate diffuser
36° narrow beam optics
IP66**

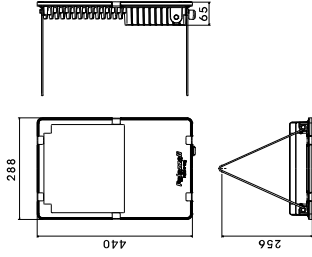
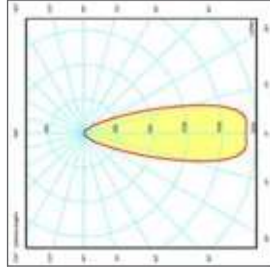

No. of LEDs	Device power (W)	Nominal flux (lm) Tj= 25 °C	Output flux (lm) Tq= 25 °C	Version	Palazzoli code	Pack Qty
4	33	4625	3757		817604DA	1
8	67	9250	7515		817608DA	1
12	99	13875	11123	dimmable	817612DA	1
16	132	18500	14831	DALI	817616DA	1
20	145	23125	16924		817620DA	1
24	170	27750	20034		817624DA	1

Equipment included: double chain bracket and busbar. Power supply with 5P quick connector.

Features: typical installation height over 6 m.

Notes: the stated values may be subject to a +/- 7% tolerance.

Wireless control systems available on request.

120000h | UGR≤22



**DALI pendant LED light fixtures
HACCP-compliant
for food industry
polycarbonate diffuser
95°x41° elliptical beam optics
IP66**

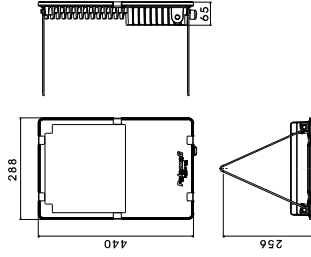
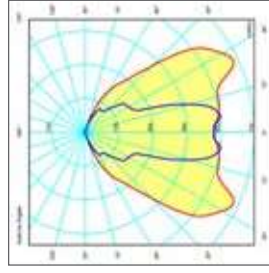

No. of LEDs	Device power (W)	Nominal flux (lm) Tj= 25 °C	Output flux (lm) Tq= 25 °C	Version	Palazzoli code	Pack Qty
4	33	4625	3864		817654DA	1
8	67	9250	7728		817658DA	1
12	99	13875	11444	dimmable	817662DA	1
16	132	18500	15258	DALI	817666DA	1
20	153	23125	17418		817670DA	1
24	182	27750	20627		817674DA	1

Equipment included: double chain bracket and busbar. Power supply with 5P quick connector.

Features: suitable for installation between the aisles of food warehouses.

Notes: the stated values may be subject to a +/- 7% tolerance.

Wireless control systems available on request.

HT +55 °C industrial



1-10V
DIMMABLE



CORROSION
RESISTANT



FLICKER
FREE



2 YEARS WARRANTY
EXTENDABLE TO 5 YEARS



ENERGY SAVING UP
TO 60%

120000h | UGR<25



HT +55°C
pendant LED light fixtures
glass diffuser
81° extra wide beam optics
IP66

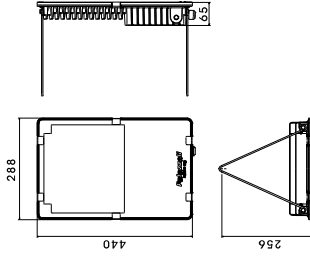
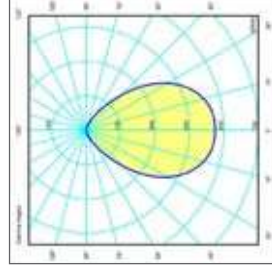

No. of LEDs	Device power (W)	Nominal flux (lm) Tj= 25 °C	Output flux (lm) Tq= 25 °C	Version	Palazzoli code	Pack Qty
4	33	4625	3477		817304HT	1
8	67	9250	6954		817308HT	1
12	74	11575	8593	1-10 V dimmable	817312HT	1
16	94	15434	10990	as standard	817316HT	1
20	112	18135	13292		817320HT	1
24	133	21761	15746		817324HT	1

Equipment included: double chain bracket and busbar. Power supply with 5P quick connector.

Features: typical installation height between 4 and 7 m.

Notes: the stated values may be subject to a +/- 7% tolerance.

Other DALI or wireless control systems are available on request.

120000h | UGR<22



HT +55°C
pendant LED light fixtures
glass diffuser
55° medium beam optics
IP66

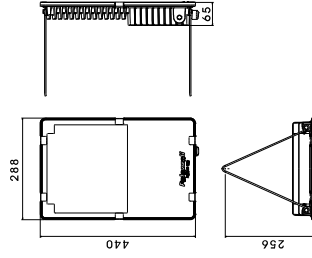
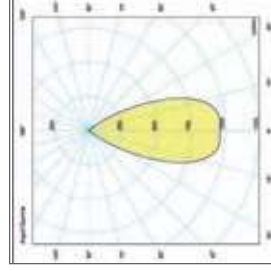

No. of LEDs	Device power (W)	Nominal flux (lm) Tj= 25 °C	Output flux (lm) Tq= 25 °C	Version	Palazzoli code	Pack Qty
4	33	4625	3328		817354HT	1
8	67	9250	6657		817358HT	1
12	74	11575	8221	1-10 V dimmable	817362HT	1
16	94	15434	10523	as standard	817366HT	1
20	112	18135	12710		817370HT	1
24	133	21761	15047		817374HT	1

Equipment included: double chain bracket and busbar. Power supply with 5P quick connector.

Features: typical installation height between 5 and 8 m.

Notes: the stated values may be subject to a +/- 7% tolerance.

Other DALI or wireless control systems are available on request.

HT +55 °C industrial



1-10V
DIMMIABLE



CORROSION
RESISTANT



FLICKER
FREE



2 YEARS WARRANTY
EXTENDABLE TO 5 YEARS



ENERGY SAVING UP
TO 60%

120000h | UGR≤22



HT +55°C
pendant LED light fixtures
glass diffuser
36° narrow beam optics
IP66

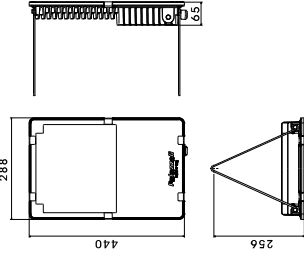
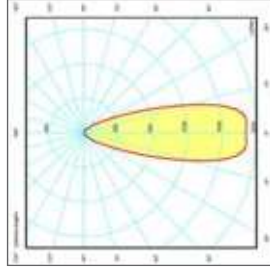

Equipment included: double chain bracket and busbar. Power supply with 5P quick connector.

Features: typical installation height over 6 m.

Notes: the stated values may be subject to a +/- 7% tolerance.

Other DALI or wireless control systems are available on request.

120000h | UGR≤22



HT +55°C
pendant LED light fixtures
glass diffuser
95°x41° elliptical beam optics
IP66

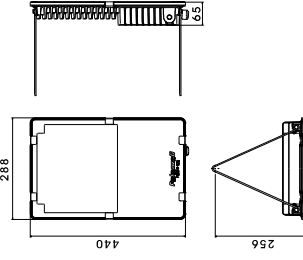
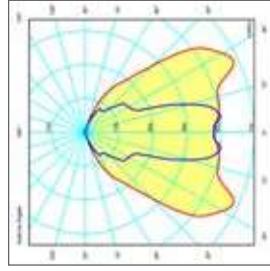

Equipment included: double chain bracket and busbar. Power supply with 5P quick connector.

Features: suitable for installation between the aisles of industrial warehouses..

Notes: the stated values may be subject to a +/- 7% tolerance.

Other DALI or wireless control systems are available on request.

No. of LEDs	Device power (W)	Nominal flux (lm) Tj= 25 °C	Output flux (lm) Tq= 25 °C	Version	Palazzoli code	Pack Qty
4	33	4625	3301		817404HT	1
8	67	9250	6602		817408HT	1
12	74	11575	8152	1-10 V dimmable	817412HT	1
16	94	15434	10500	as standard	817416HT	1
20	112	18135	12601		817420HT	1
24	133	21761	14917		817424HT	1

No. of LEDs	Device power (W)	Nominal flux (lm) Tj= 25 °C	Output flux (lm) Tq= 25 °C	Version	Palazzoli code	Pack Qty
4	33	4625	3395		817454HT	1
8	67	9250	6789		817458HT	1
12	74	11575	8387	1-10 V dimmable	817462HT	1
16	94	15434	10735	as standard	817466HT	1
20	112	18135	12969		817470HT	1
24	133	21761	15359		817474HT	1

Accessories



0-90° adjustable bracket
for double chain mounting

Manufacturing material	Palazzoli code	Pack Qty
galvanized steel	811919	1



Set of brackets
for Ø 60mm horizontal pole mounting

Manufacturing material	Palazzoli code	Pack Qty
galvanized steel	811920	1



Kit with bracket
for ceiling mounting

Manufacturing material	Palazzoli code	Pack Qty
galvanized steel	811916	1



0-90° adjustable bracket
for catenary wire mounting

Manufacturing material	Palazzoli code	Pack Qty
galvanized steel	811921	1



Emergency kit

Manufacturing material	Emergency duration	Palazzoli code	Pack Qty
aluminium alloy box and galvanized steel bracket	1h	811923	1
	3h	811924	1

Equipment included: the emergency kit comes complete with junction box, battery, inverter and interface bracket.

Features: 1 M20 entry;

1 output with connector.

Notes: the interface bracket is suitable for a double fixed chain connection. In the case of horizontal pole mounting, adjustable mounting and ceiling mounting, the emergency kit must be mounted close to the unit (max. 1.5 m).

Nominal flux (lm) Tj= 25 °C	Emergency output flux (lm) 1-3 h
4625	
9250	
13875	
18500	995
23125	
27750	

Dimensions

Wall mounting with bracket

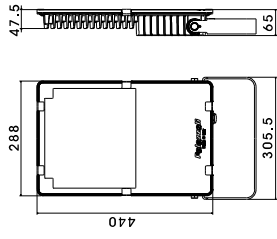

Pole-top mounting with accessories

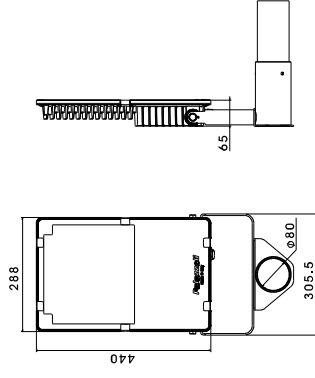

Wall mounting with projecting bracket

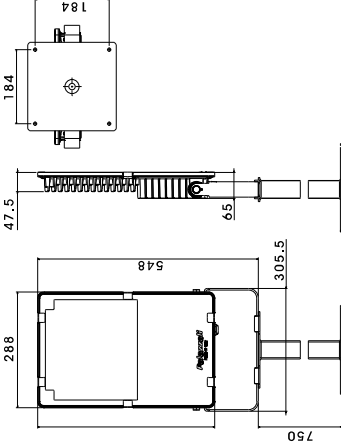

Pole mounting with collar

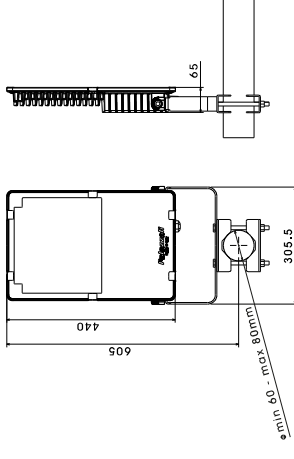

Double chain suspension

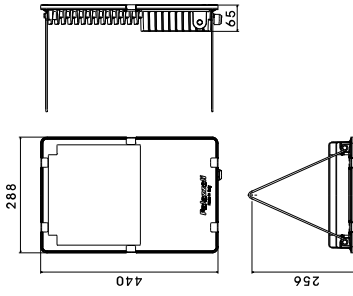

Adjustable double chain suspension

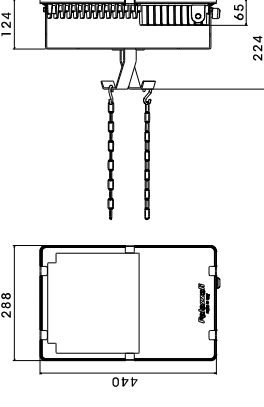

Ceiling mounting

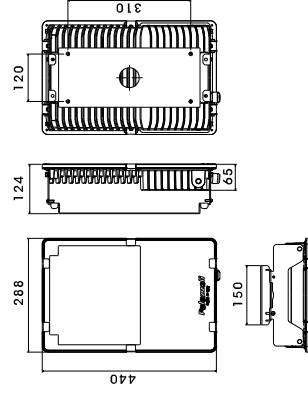

Horizontal pole mounting

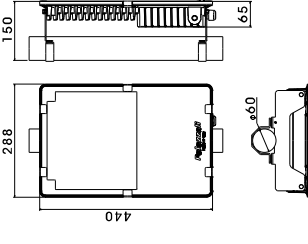

Catenary wire suspension

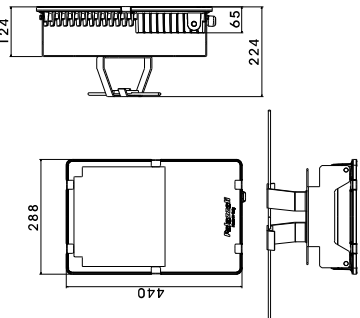

Integrated pole-top mounting

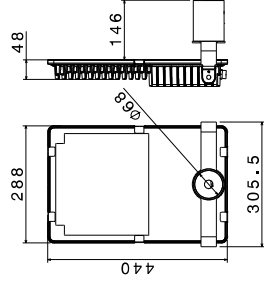

Emergency

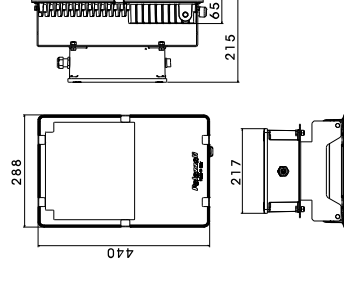

Complete offer

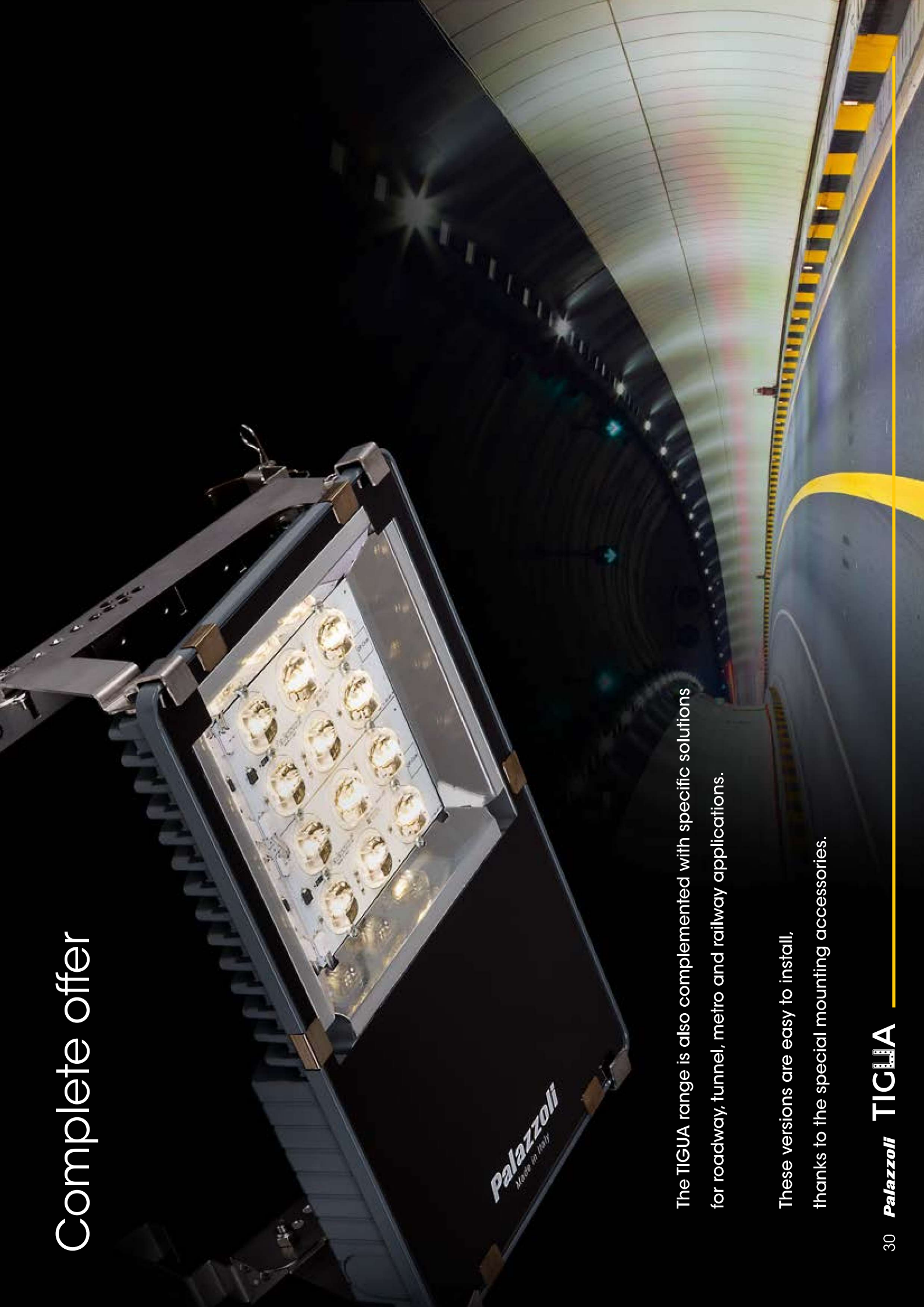

Palazzoli
Made in Italy

The TIGUA range is also complemented with specific solutions for roadway, tunnel, metro and railway applications.

These versions are easy to install, thanks to the special mounting accessories.

LED solutions for any application

	RINO	META	TIGUA Floodlight	TIGUA Low bay	TIGUA Roadway	TIGUA Tunnel
	AISI 304 stainless steel or painted galvanized steel IP66 L80 B20 @ 50,000h CRI ≥ 80	EN 46100 aluminium IP66/Ip7 L80 B20 @ 110,000h CRI ≥ 80	EN 44300 aluminium IP66 L80 B20 @ 100,000h CRI ≥ 80	EN 44300 aluminium IP66 L80 B20 @ 120,000h CRI ≥ 80	EN 44300 aluminium IP66 L90 B10 @ 110,000h CRI ≥ 70	EN 44300 aluminium IP66 L90 B10 @ 110,000h CRI ≥ 70
	2 kV surge protection	6-10 kV surge protection	6-8 kV surge protection	6-8 kV surge protection	8-10 kV surge protection	8-10 kV surge protection
						
	4100 - 12200 lm	13230 - 26460 lm	9250 - 27750 lm	4625 - 21761 lm	5220 - 19575 lm	5220 - 58725 lm
Industry	✓	✓		✓		
Atex	✓	✓				
Floodlights		✓	✓			
Roadway					✓	
Tunnel	✓					✓
Marine	✓					

Certified quality

Palazzoli is certified to ISO 9001. All light fixtures are made in Italy and certified according to the application, by ENEC, CESI, RINA, ATEX, IECEx and QL (photobiological safety and flicker free performance, impact resistance for sports facilities).

